

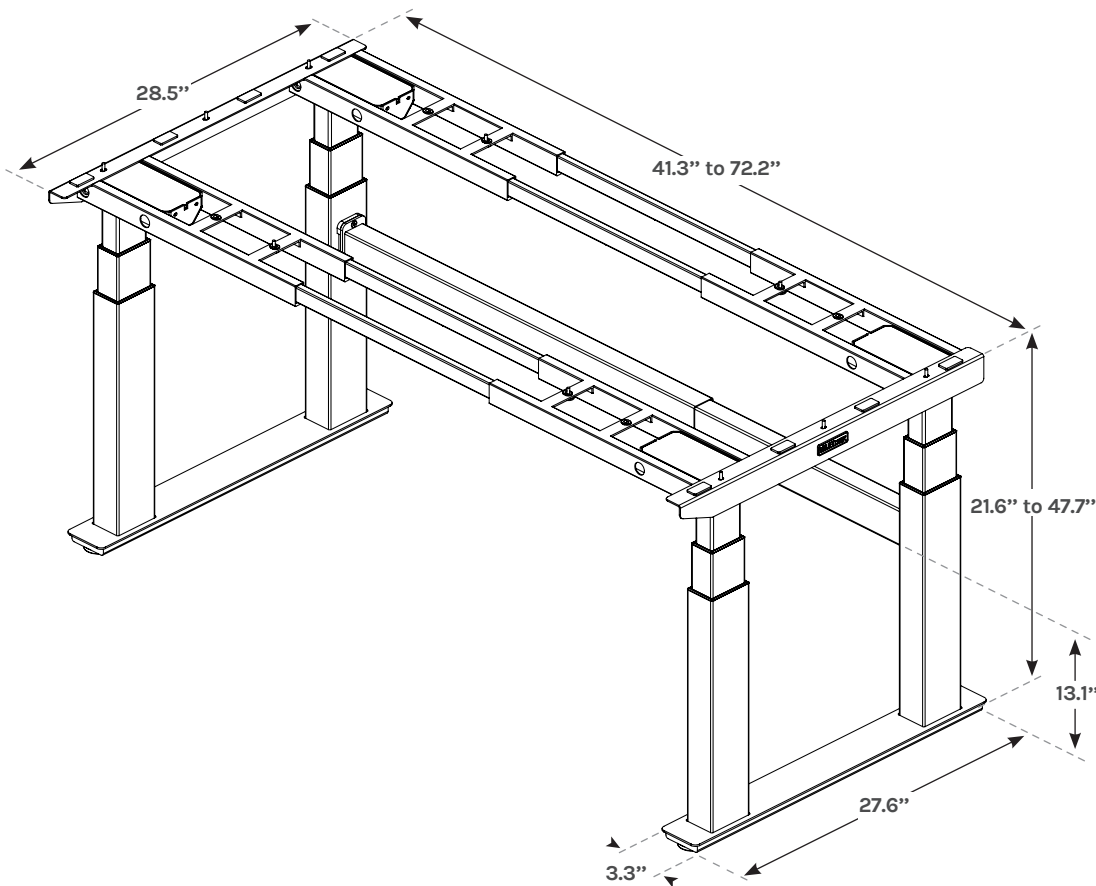











# UPLIFT V2-Commercial 4-Leg Standing Desk Specifications

SKU: FRM680



**Contract-grade  
Quality**

-  **Quad Motor Design**
  -  **3-Stage Legs Are 33% Faster Than 2-Stage Legs**
  -  **Superior Anti-Collision Sensitivity**
  -  **Whisper-Quiet Adjustment**
  -  **Stability Crossbar**
  -  **Improved Stability with 33% Larger, Precision Tolerance Legs**
  -  **Available in 4 Color Options**
  -  **Included Under-Desk Wire Management**
  -  **Meets BIFMA X5.5-2021 Durability Standard**
  -  **Meets BIFMA G1-2013 Height Standard**
-  For a more in-depth look at this product, see our product video at [upliftdesk.com/4leg-com](https://upliftdesk.com/4leg-com)



Copyright Notice: This guide is a component of this UPLIFT Desk product. This guide is a part of the scope of delivery, even if the item is resold. This guide is also available on the UPLIFT Desk website: [upliftdesk.com](https://upliftdesk.com). These specifications are subject to United States copyright law.

<b>Height range</b>	21.6" - 47.7" H (22.6" - 48.7" H with 1" desktop), which meets BIFMA G1-2013 height requirement
<b>Height travel</b>	26.1"
<b>Width range</b>	41.3" - 72.2"
<b>Desktop width compatibility</b>	42" - 80" wide desktops
<b>Travel speed</b>	1.6" per second with soft start/stop actuator motors, depending on load
<b>Noise level</b>	Less than 50 decibels during motion, silent when not in motion
<b>Lifting capacity</b>	535 lb (inclusive of desktop weight)
<b>Adjustable foot leveling studs</b>	0.38" adjustment for uneven flooring
<b>Electrical input</b>	100-120VAC, 50/60Hz (600W max)
<b>Desktop thickness</b>	1" - 1.75", depending on desktop style
<b>Desktop width</b>	60" or wider
<b>ANSI/BIFMA X5.5-2021 desk standard</b>	Both the UPLIFT V2 and UPLIFT V2-Commercial Frame are compliant to ANSI/BIFMA X5.5-2021 Desk/Table Products for safety, durability, and structural performance including Height Adjustable Desk/Table Surface tests.
<b>ANSI/BIFMA G1-2013 height standard</b>	<p>UPLIFT V2-Commercial Frame is ANSI/BIFMA G1-2013 Height Standard compliant when used with a 1" thick desktop.</p> <p>This makes the V2-Commercial desk suitable for most users, accommodating a seated 5th percentile (5'0") to a standing 95th percentile (6'3").</p> <p>Add a keyboard tray as you configure your desk. With a keyboard tray the V2-Commercial desk accommodates users 4'34" tall and up, while the V2 desk accommodates users 4'8" tall and up.</p>
<b>CAN/CGSB 44.227-2008E certification</b>	Canadian desktop deflection specification compliant with section 6.6.1/8.4 Surface Deflection
<b>Safety certifications</b>	UL (U.S.)/CSA (Canada): Lifting Column, Power Cord, & Control Box
<b>Shipping dimensions</b>	<p>Desktop dimensions will vary depending on selection</p> <p><b>All Frame Types:</b></p> <p>Frame Box 1: 12" W x 10" H x 42" D, 66 lb            Frame Box 2: 12" W x 10" H x 42" D, 56 lb</p> <p><b>V2-Commercial Frames:</b></p> <p>V2-Commercial Frame Feet Box: 6.4" W x 3.5" H x 36" D, 16.5 lb            V2-Commercial Frame Crossbar Box: 7.63" W x 6.13" H x 40.75" D, 14.9 lb</p>