

Compact Desk Drawer

STR031

UPLIFT DESK

Package Contents

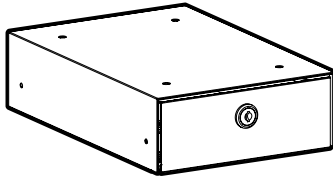

Drawer



#10x5/8" Wood screws
(qty 4)



Keys
(qty 2)

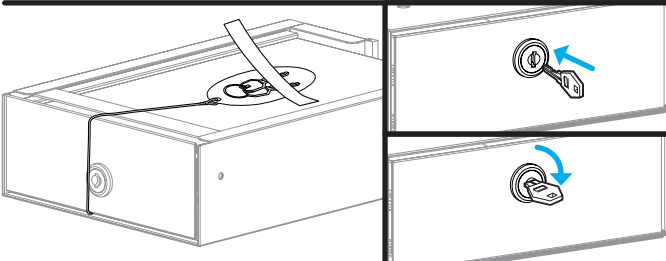

Step 1

Remove the keys, which you will find in a plastic bag, taped to the bottom of the drawer.

Turn the drawer right-side up, and unlock the drawer turning the key 90 degrees clockwise.

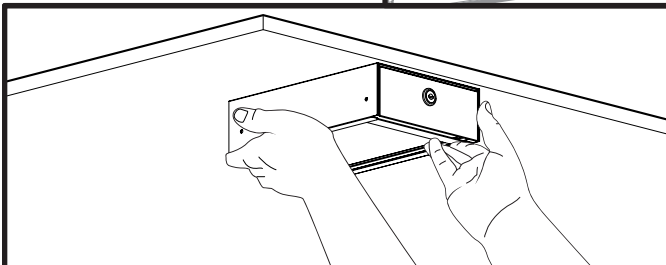

Step 2

Determine the placement of the drawer before mounting it by holding it under your desk, just about flush with the front edge.

Note: If your desk is still being assembled and is upside down, you can do this step by yourself. If your desk is already right-side up, ask a friend for assistance.

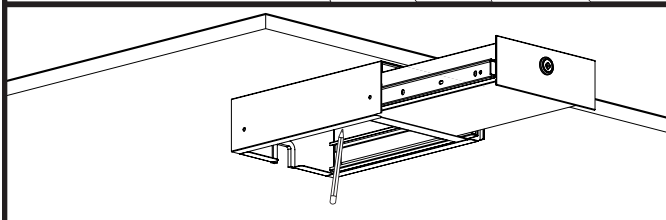

Step 3

Open the drawer and place the whole unit in the spot that you've chosen (if the desk is right-side up, have a friend hold it in place). Use a pencil to mark the location of the four screw holes in the top of the drawer housing.

If you own a drill, you can make this a little easier by drilling pilot holes where you've made your marks using a 1/8" diameter bit.

Note: DRILL NO DEEPER THAN 1/2". To ensure this, we recommend wrapping a piece of tape around your drill bit 1/2" from the tip. Stop drilling just before the tape touches the desktop.

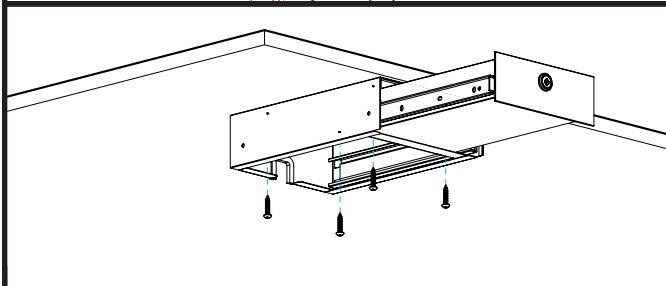
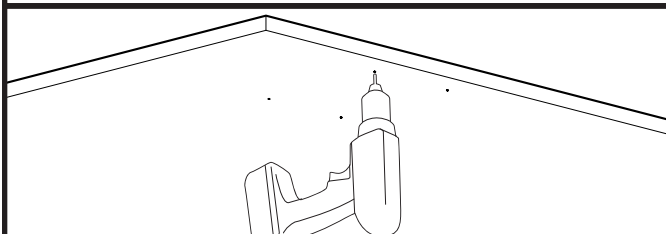
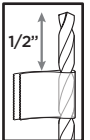

Step 4

Before inserting the screws, hold one up next to the desk's edge to double check that it is not too long compared to desk-top thickness.

Once more, have a friend hold the whole unit in place, insert four (4) Wood screws into the pilot holes, and tighten down all the way.

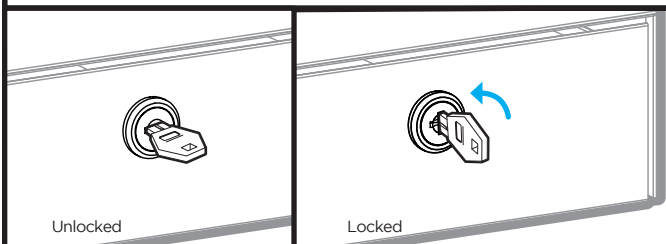

Step 5

When you want to lock the drawer, simply insert one of the Keys and rotate it 90° counterclockwise, so the key slot is in the vertical position. To unlock, turn the Key back in the opposite direction, 90° clockwise.

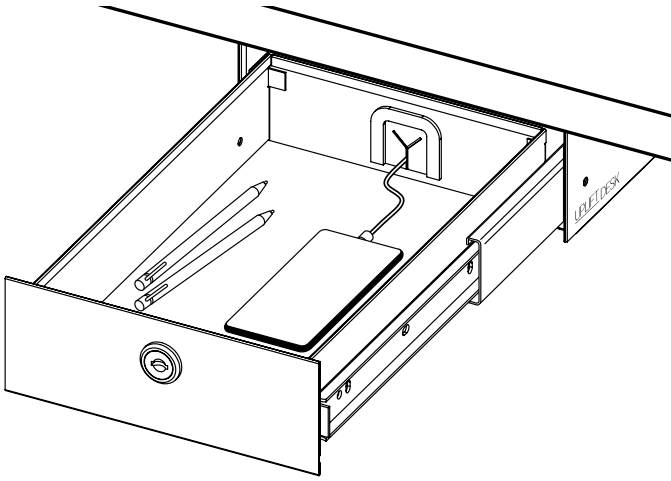

Step 6

You can now add your personal items to the drawer such as your phone, your wallet, small office accessories, and personal items you want to keep under lock and key.

If you store electronics inside the drawer and want to keep them charging, you can route the cables through the pass-through on the back of drawer. Just slide the skinny part of the cord through the back of the opening, and pull through on the inside, giving it enough slack to reach your device and allow you to open and close the drawer without pulling on the cord.

⚠ CAUTIONS & WARNINGS

⚠ **CAUTION:** Read all instructions before assembly. Failure to assemble properly may result in damage or personal injury.

© **Copyright Notice:** This guide is a component of the UPLIFT Slim Drawer. This guide is a part of the scope of delivery, even if the item is resold. This guide is also available on the UPLIFT Desk website: upliftdesk.com. Excerpts or copies may not be forwarded to third parties or used in any other published form without the prior written consent of UPLIFT Desk. These instructions are subject to United States copyright law.