

# UPLIFT DESK<sup>®</sup> Laptop Holder Instructions

UPL023

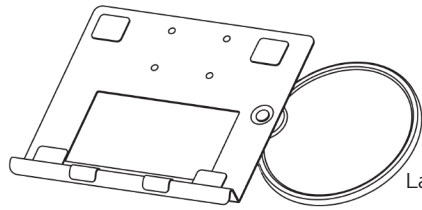

Laptop tray



Elastic belt  
(qty 2)



Tray mount



M4 Plastic screws  
(qty 4)

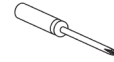

Screwdriver



M4 Sink head screws  
(qty 4)

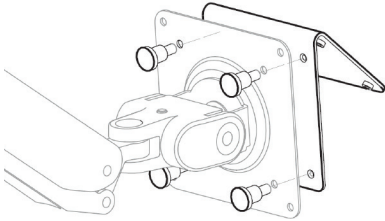

## Step 1

Fasten the laptop mount to the VESA plate of the monitor arm using the four (4) M4 Plastic screws. Tighten by hand.

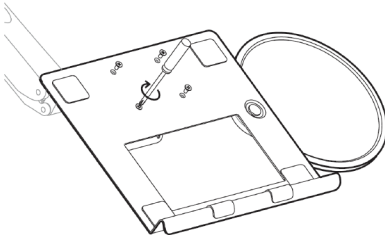

## Step 2

Fasten the laptop tray to the laptop mount, using four (4) M4 Sink Head screws. Tighten with the Screwdriver.

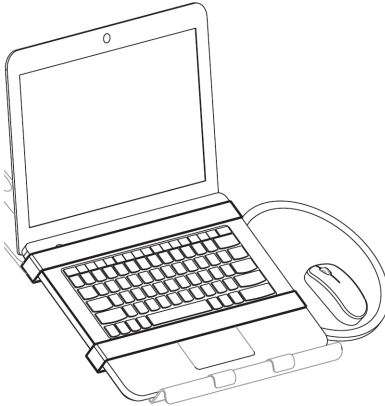

## Step 3

To secure the laptop, wrap the Elastic belts around the laptop and the Laptop tray, as shown in the picture.

### Laptop Tray Dimensions

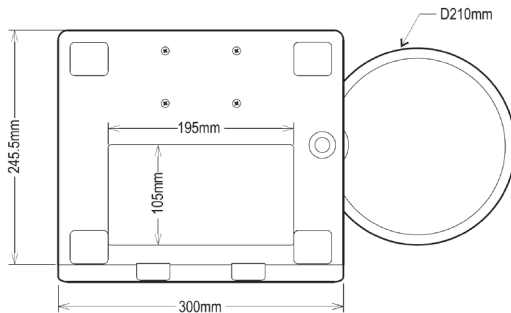

### Mouse Tray Rotation

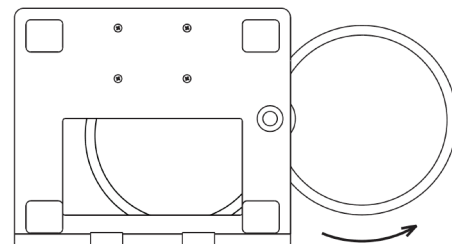

When not in use, the Mouse Tray can be turned inward to be kept out of the way.

When the Mouse Tray is needed, just rotate it outward.

© **Copyright Notice:** This guide is a component of the UPLIFT Laptop Tray. This guide is a part of the scope of delivery, even if the item is resold. This guide is also available on the UPLIFT Desk website: [upliftdesk.com](http://upliftdesk.com). Excerpts or copies may not be forwarded to third parties or used in any other published form without the prior written consent of UPLIFT Desk.

These instructions are subject to United States copyright law.